

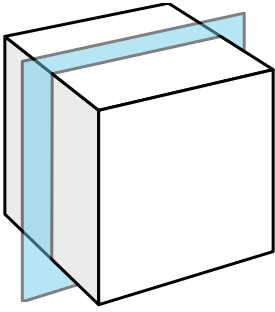

Determine the 2d shape that would be created if the 3d shape were sliced as shown.

1)



2)

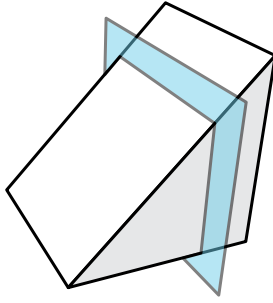

3)

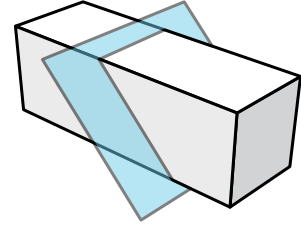

4)

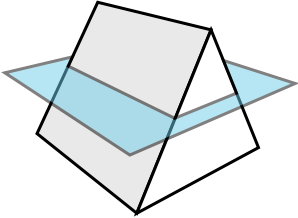

5)

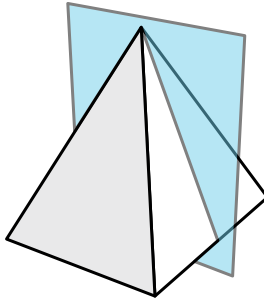

6)

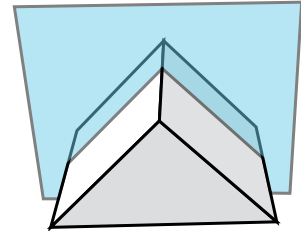

7)

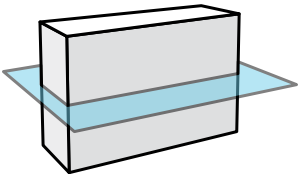

8)

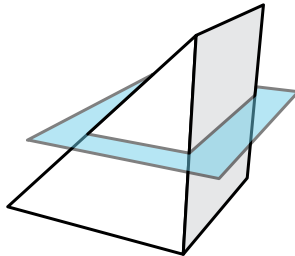

9)

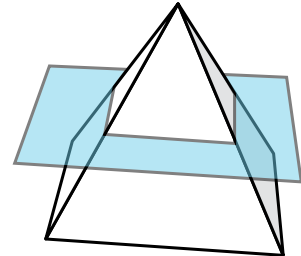



Determine the 2d shape that would be created if the 3d shape were sliced as shown.

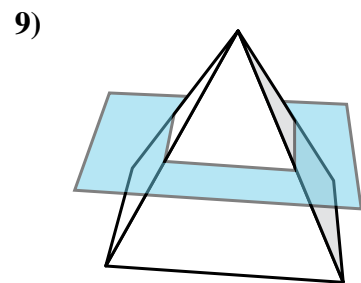
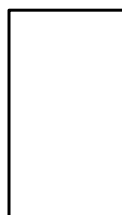
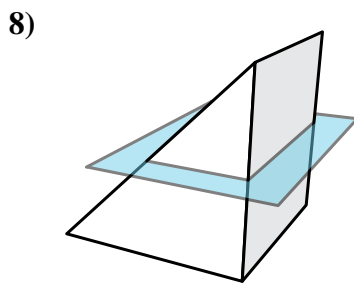
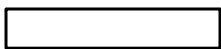
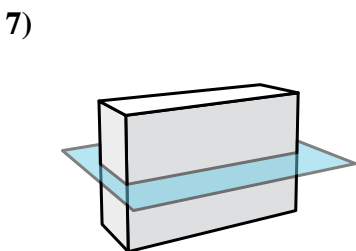
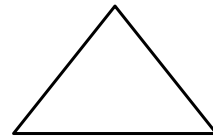
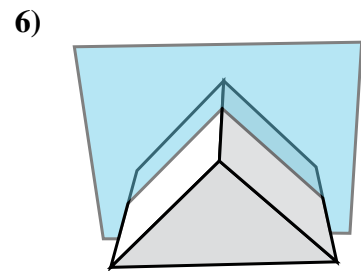
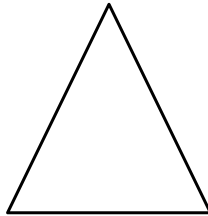
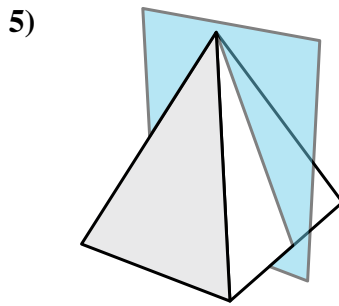
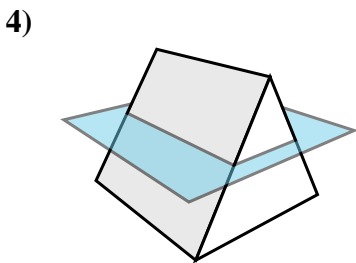
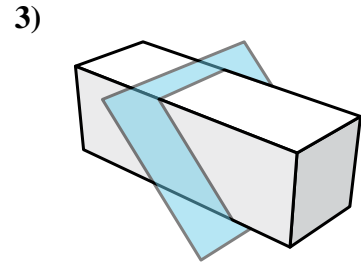
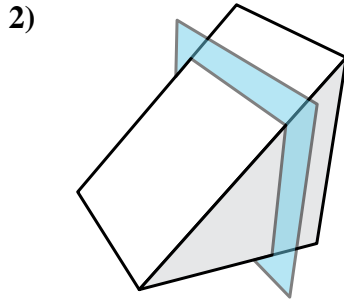
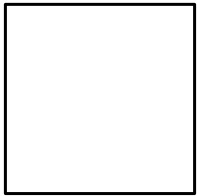
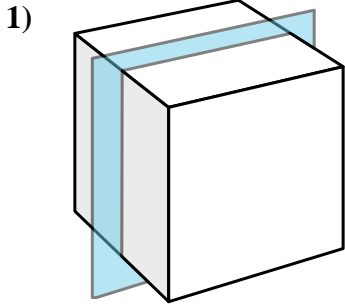



Determine the 2d shape that would be created if the 3d shape were sliced as shown.

1)

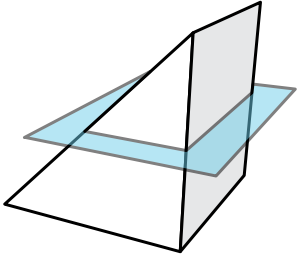

2)

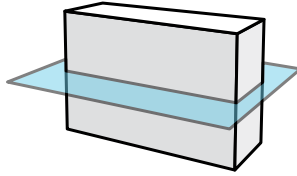

3)

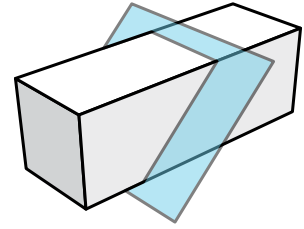

4)

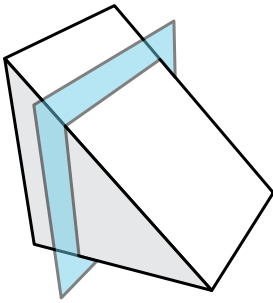

5)

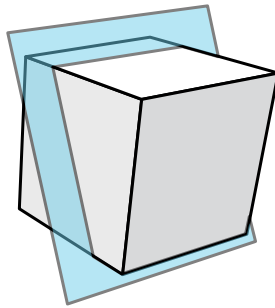

6)

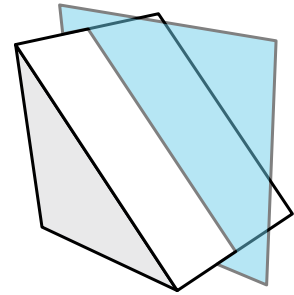

7)

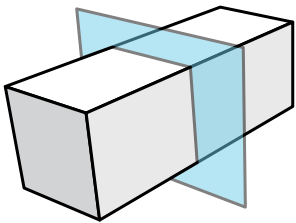

8)

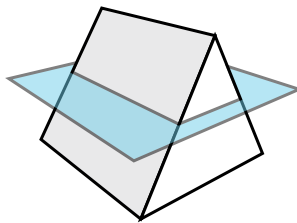

9)

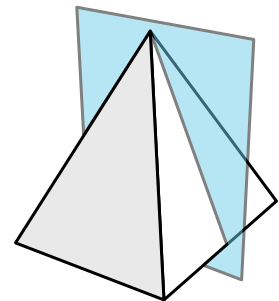



Determine the 2d shape that would be created if the 3d shape were sliced as shown.

1)

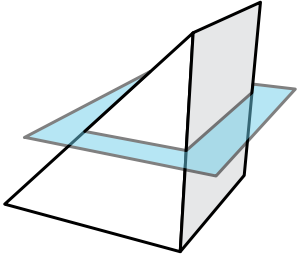

2)

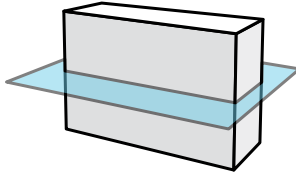

3)

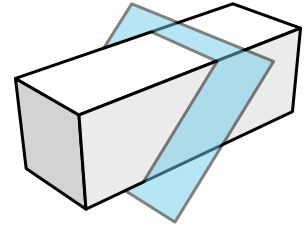

4)

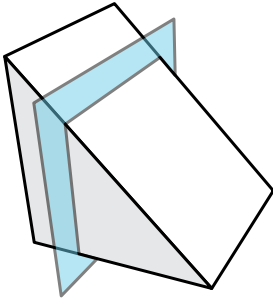

5)

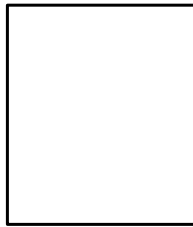
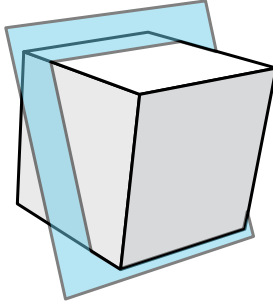

6)

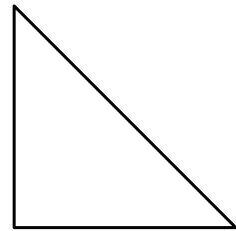
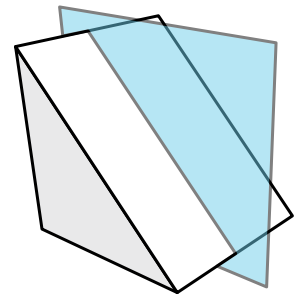

7)

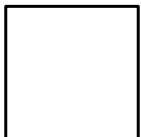
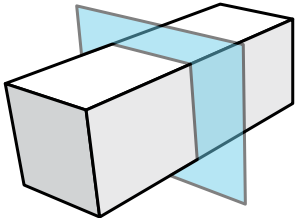

8)

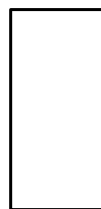
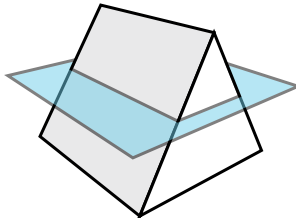

9)

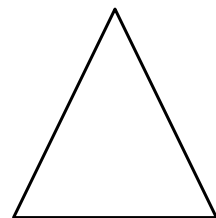
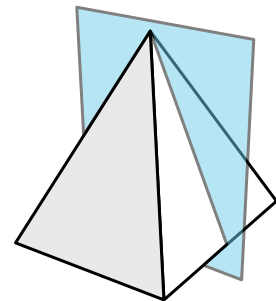



Determine the 2d shape that would be created if the 3d shape were sliced as shown.

1)

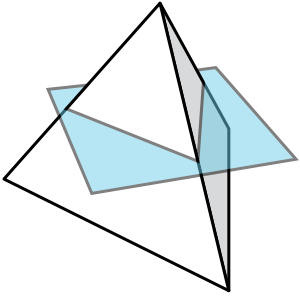

2)

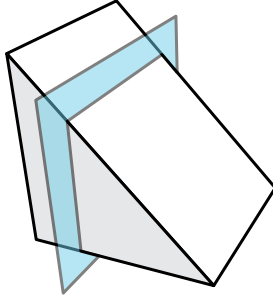

3)

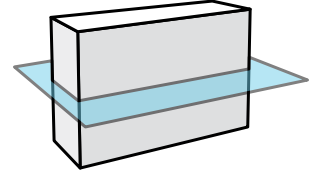

4)

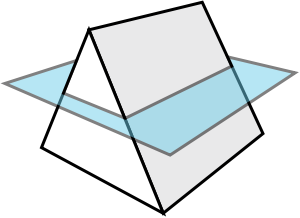

5)

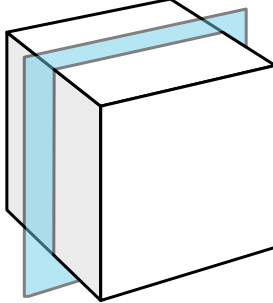

6)

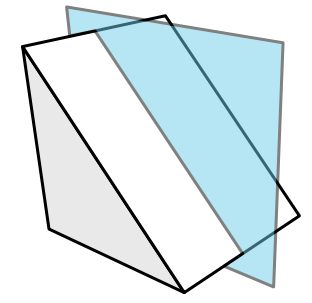

7)

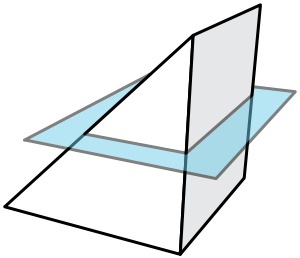

8)

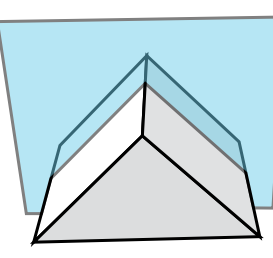

9)

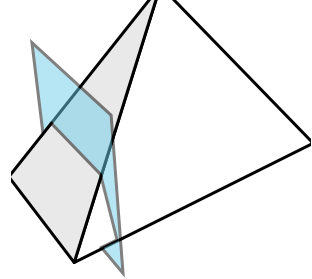



Determine the 2d shape that would be created if the 3d shape were sliced as shown.

1)

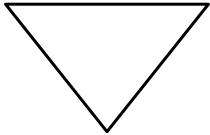
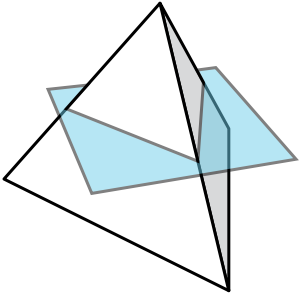

2)

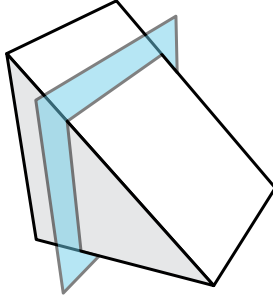

3)

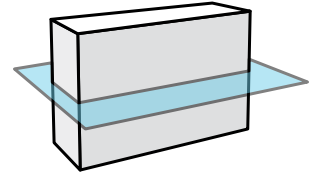

4)

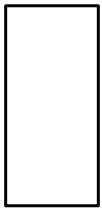
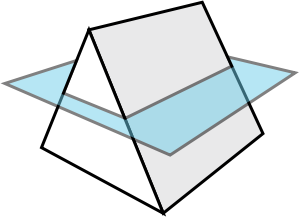

5)

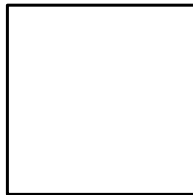
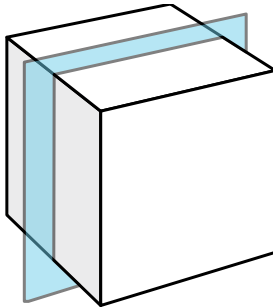

6)

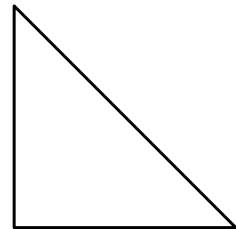
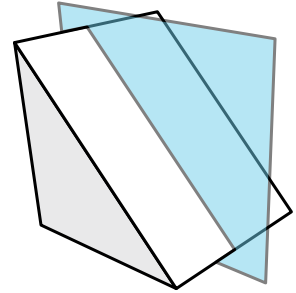

7)

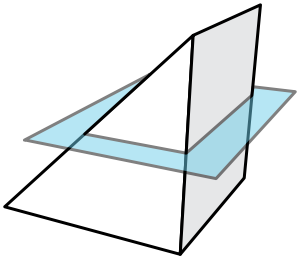

8)

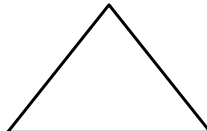
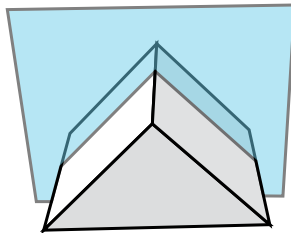

9)

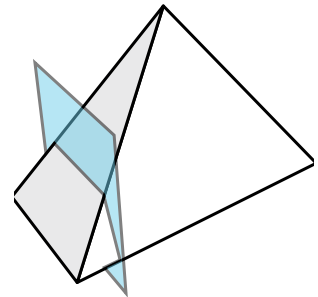

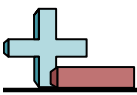

Determine the 2d shape that would be created if the 3d shape were sliced as shown.

1)

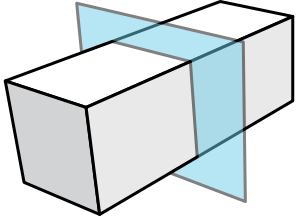

2)

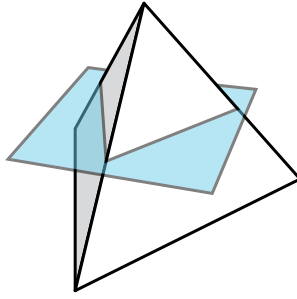

3)

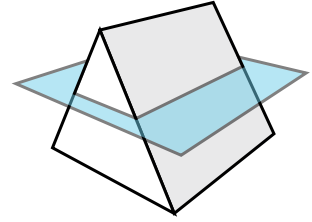

4)

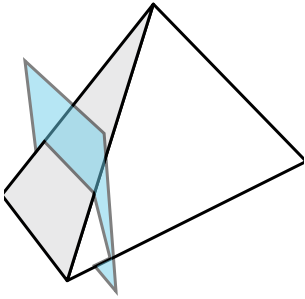

5)

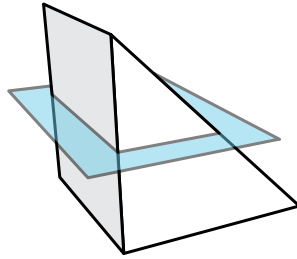

6)

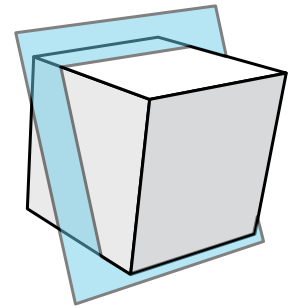

7)

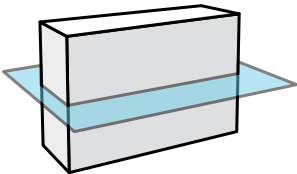

8)

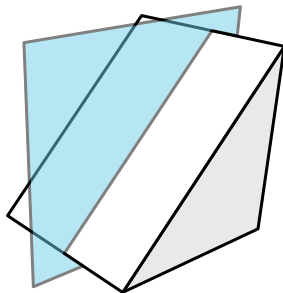

9)

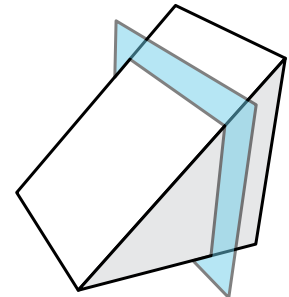



Determine the 2d shape that would be created if the 3d shape were sliced as shown.

1)

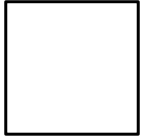
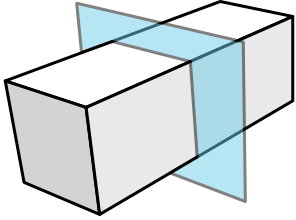

2)

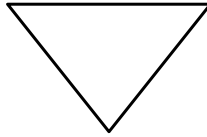
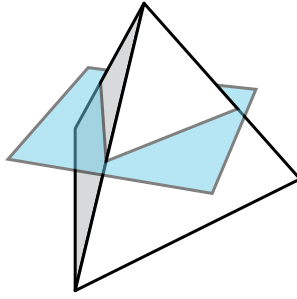

3)

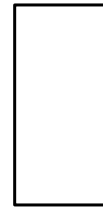
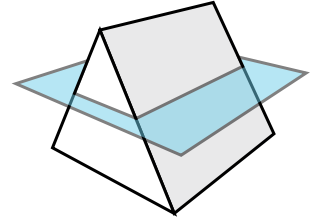

4)

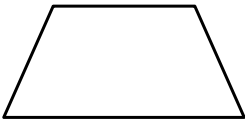
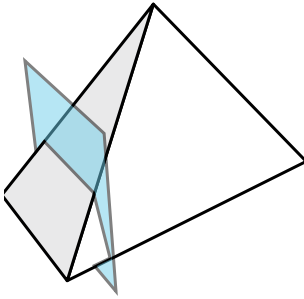

5)

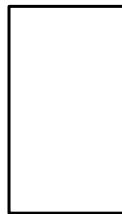
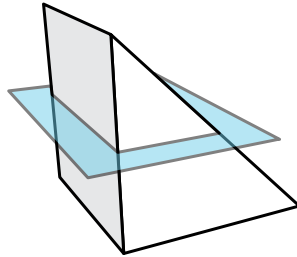

6)

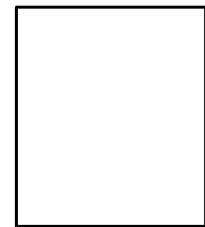
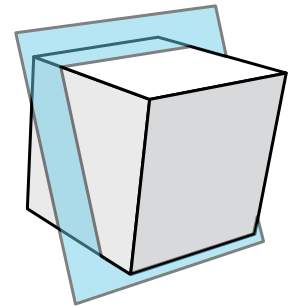

7)

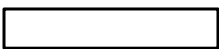
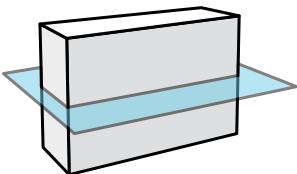

8)

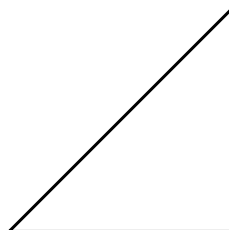
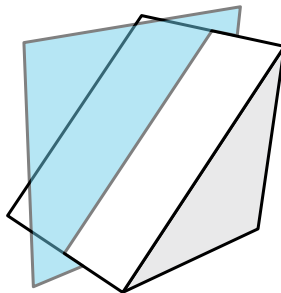

9)

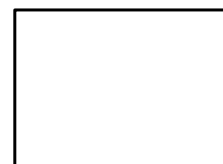
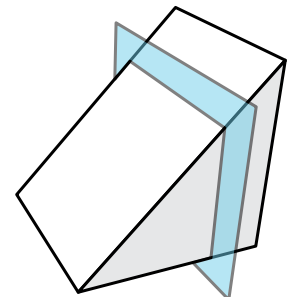





Determine the 2d shape that would be created if the 3d shape were sliced as shown.

1)

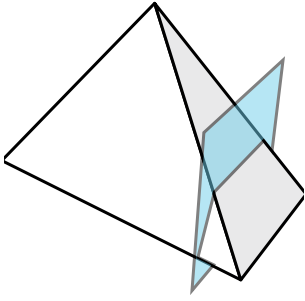

2)

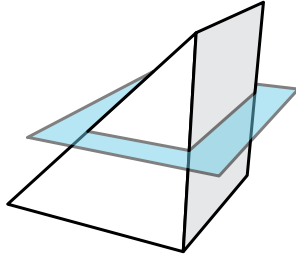

3)

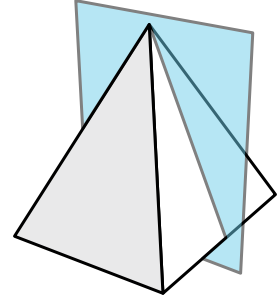

4)

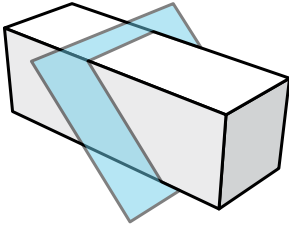

5)

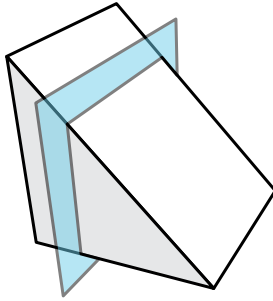

6)

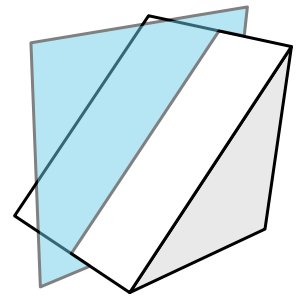

7)

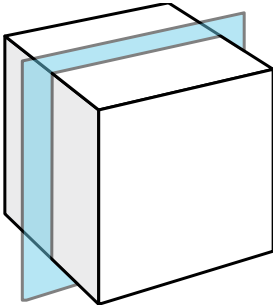

8)

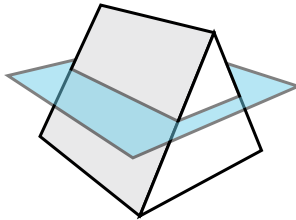

9)

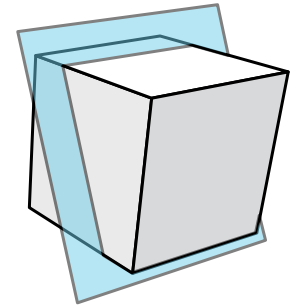



Determine the 2d shape that would be created if the 3d shape were sliced as shown.

1)

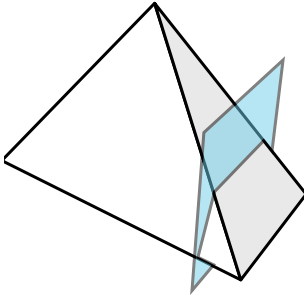

2)

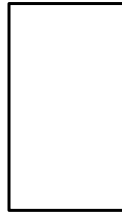
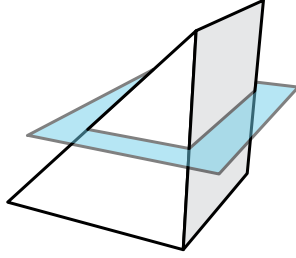

3)

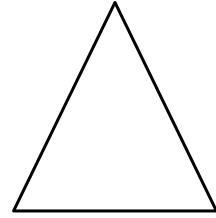
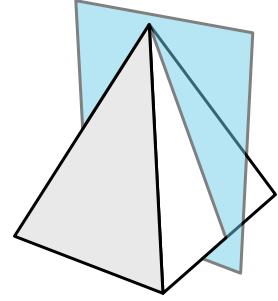

4)

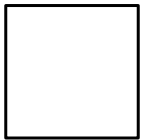
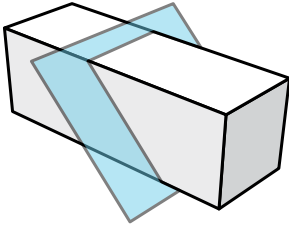

5)

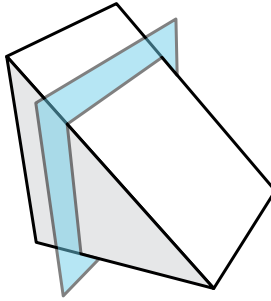

6)

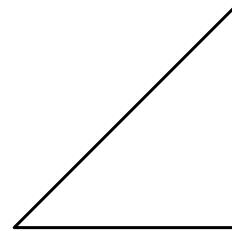
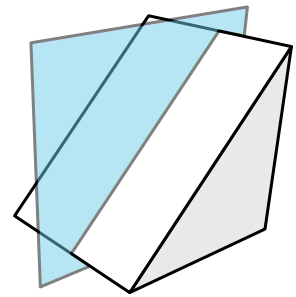

7)

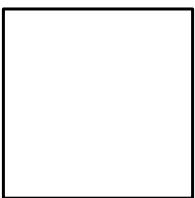
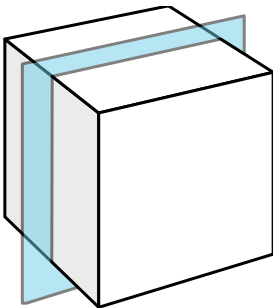

8)

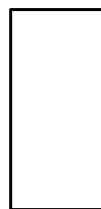
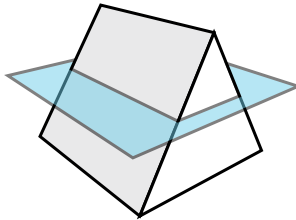

9)

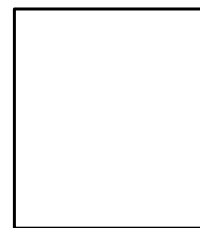
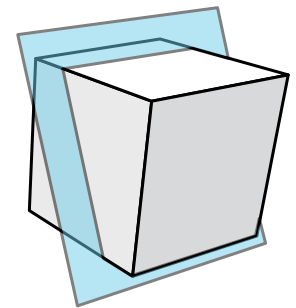



Determine the 2d shape that would be created if the 3d shape were sliced as shown.

1)

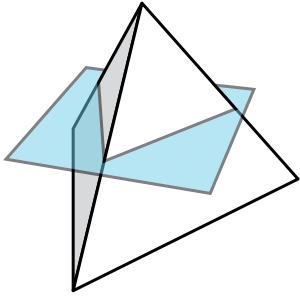

2)

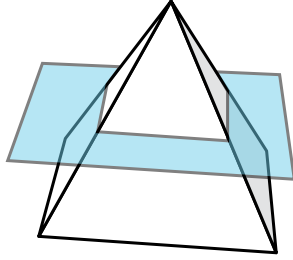

3)

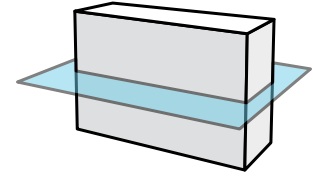

4)

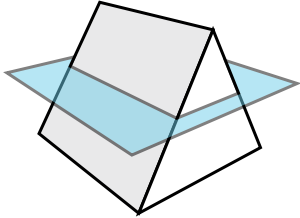

5)

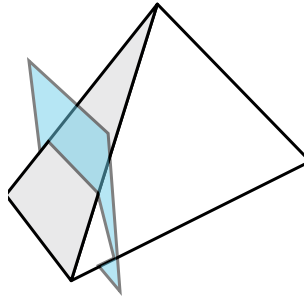

6)

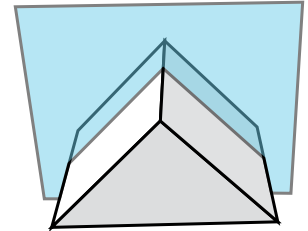

7)

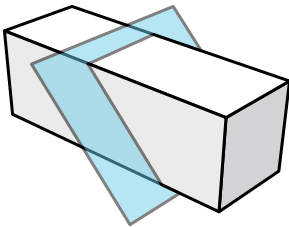

8)

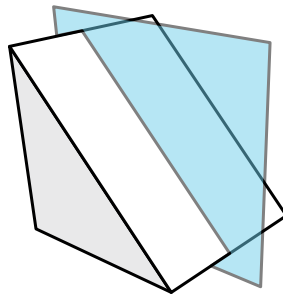

9)

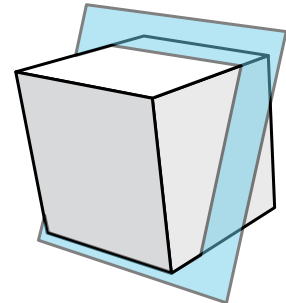



Determine the 2d shape that would be created if the 3d shape were sliced as shown.

1)

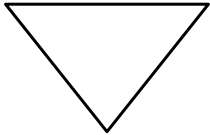
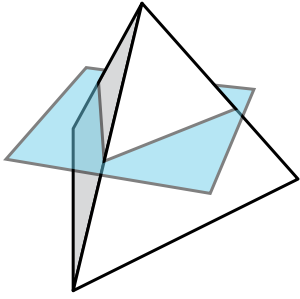

2)

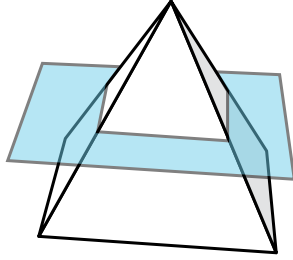

3)

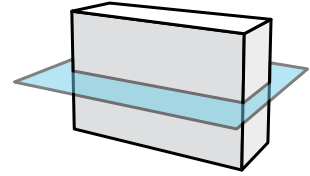

4)

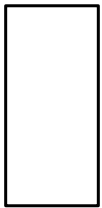
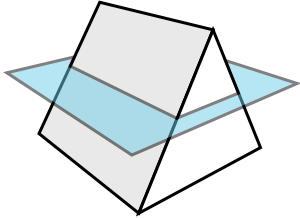

5)

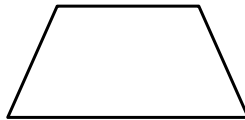
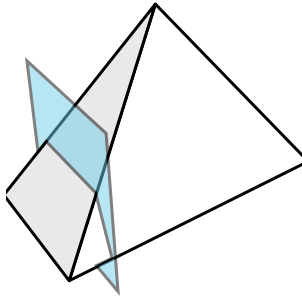

6)

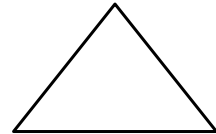
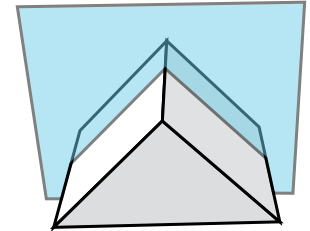

7)

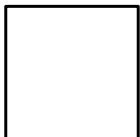
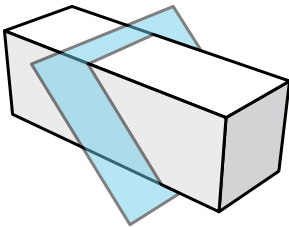

8)

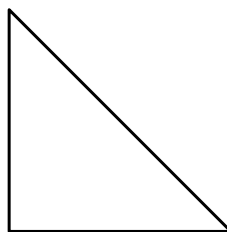
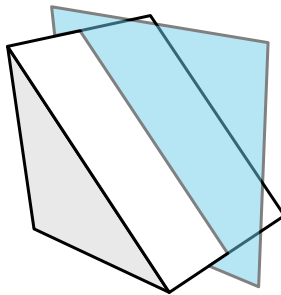

9)

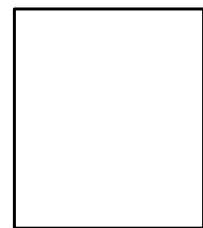
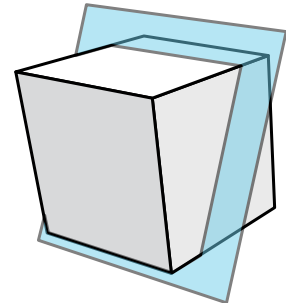



Determine the 2d shape that would be created if the 3d shape were sliced as shown.

1)

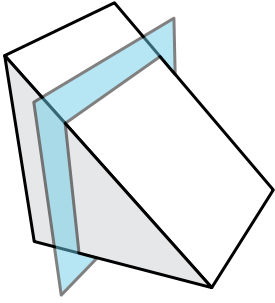

2)

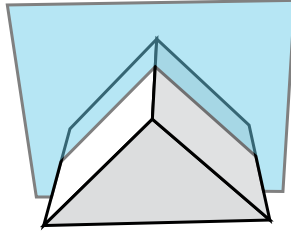

3)

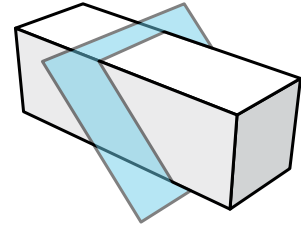

4)

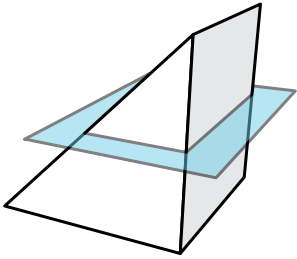

5)

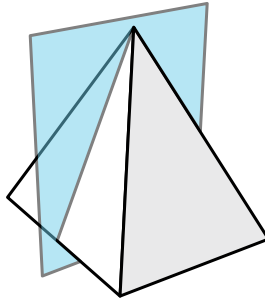

6)

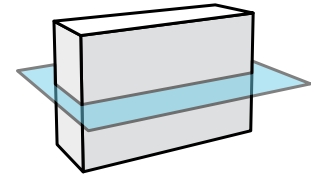

7)

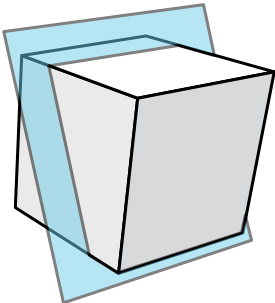

8)

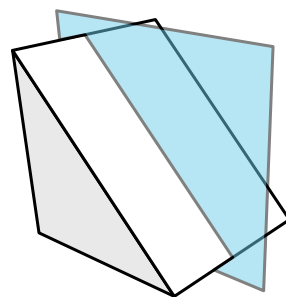

9)

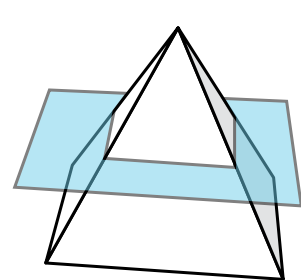



Determine the 2d shape that would be created if the 3d shape were sliced as shown.

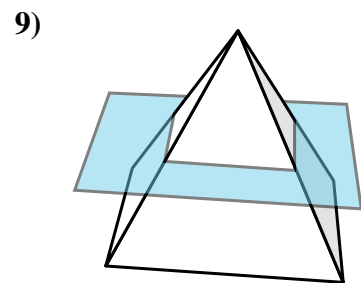
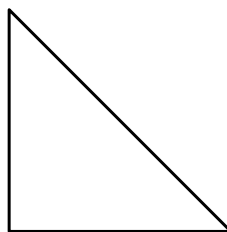
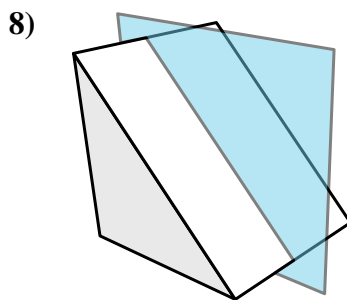
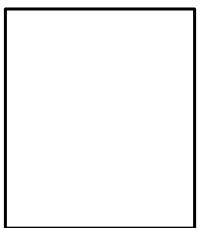
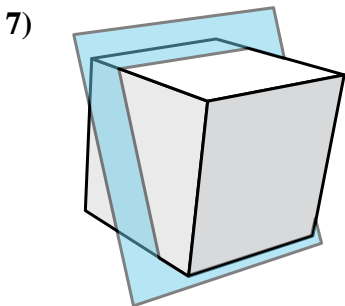
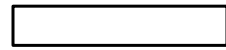
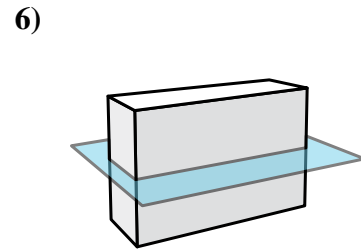
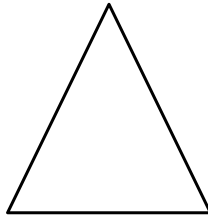
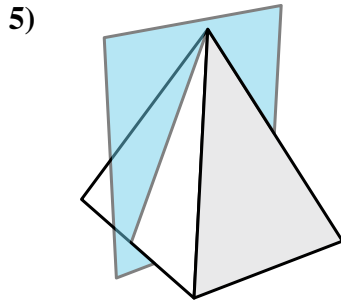
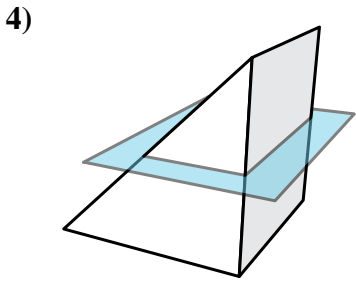
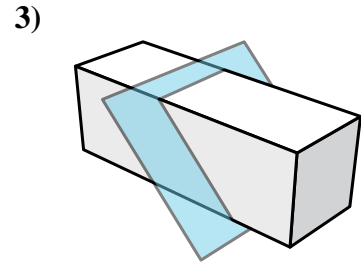
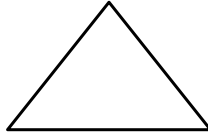
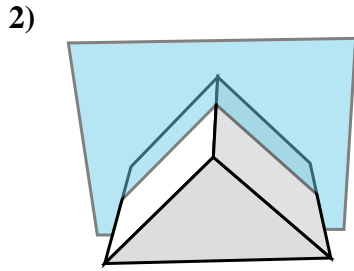
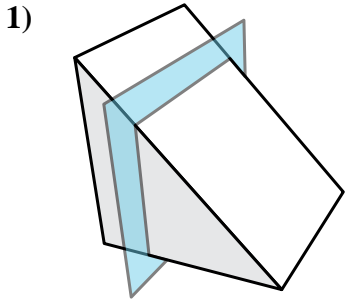



Determine the 2d shape that would be created if the 3d shape were sliced as shown.

1)

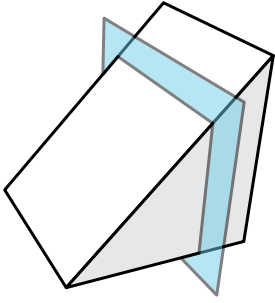

2)

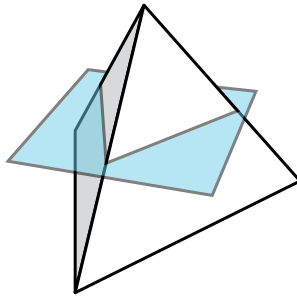

3)

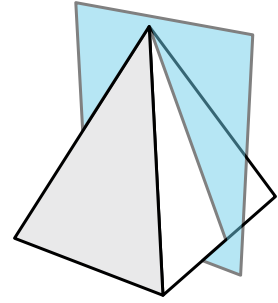

4)

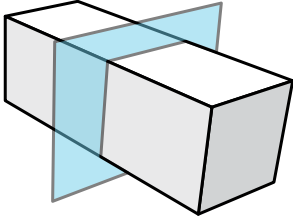

5)

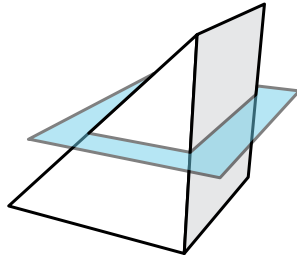

6)

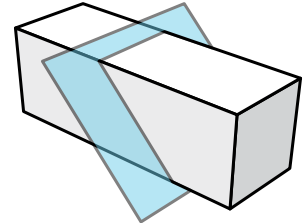

7)

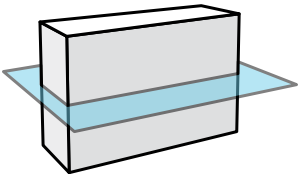

8)

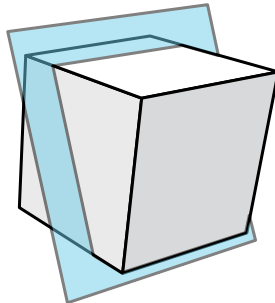

9)

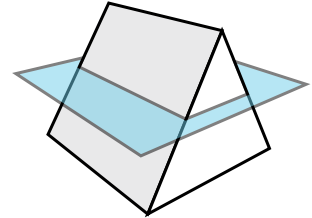



Determine the 2d shape that would be created if the 3d shape were sliced as shown.

1)

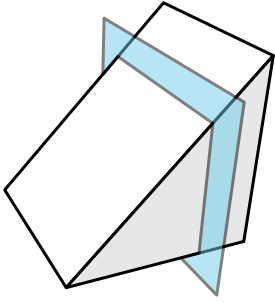

2)

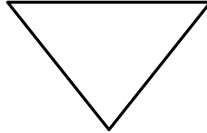
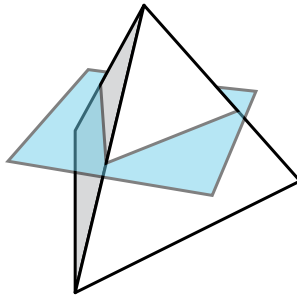

3)

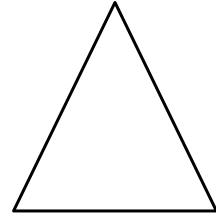
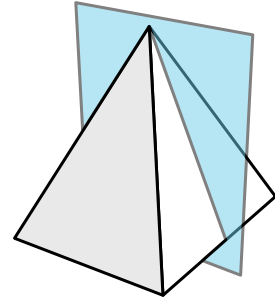

4)

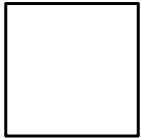
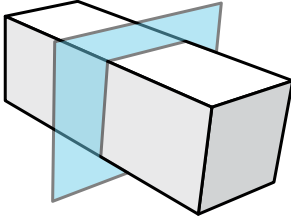

5)

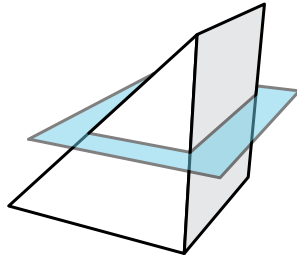

6)

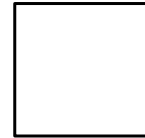
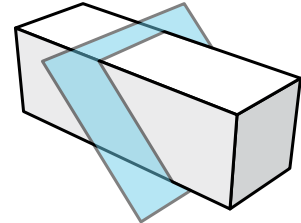

7)

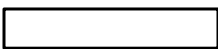
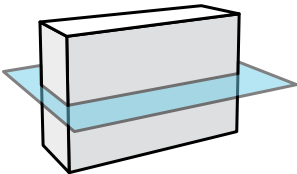

8)

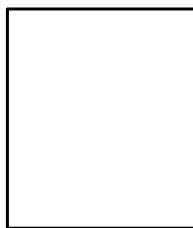
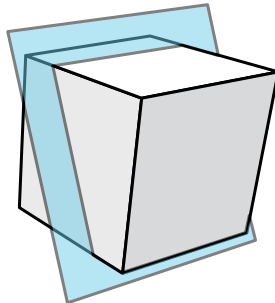

9)

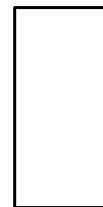
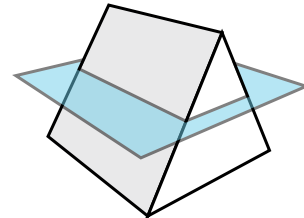





Determine the 2d shape that would be created if the 3d shape were sliced as shown.

1)

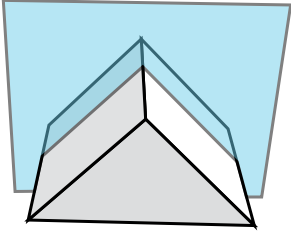

2)

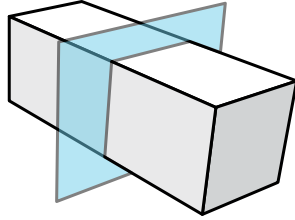

3)

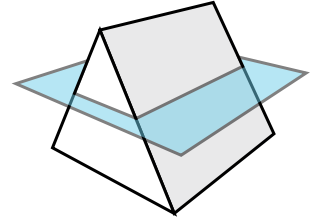

4)

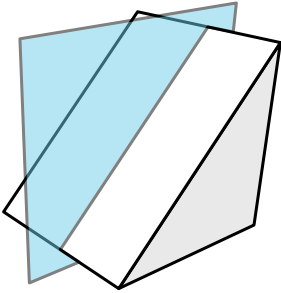

5)

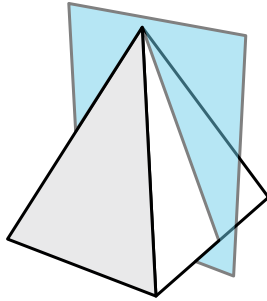

6)

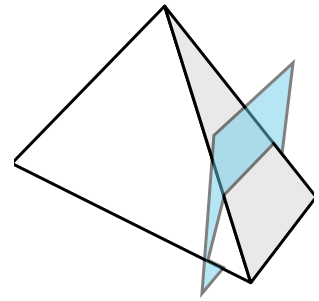

7)

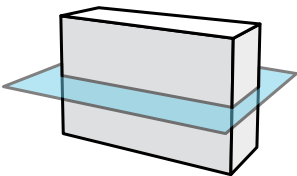

8)

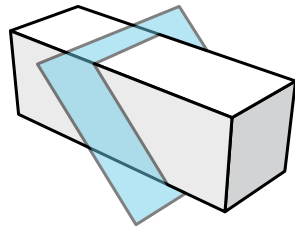

9)

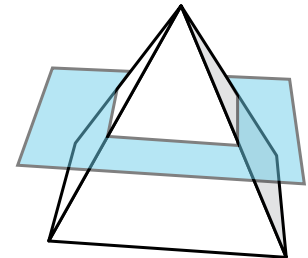



Determine the 2d shape that would be created if the 3d shape were sliced as shown.

1)

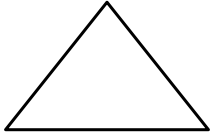
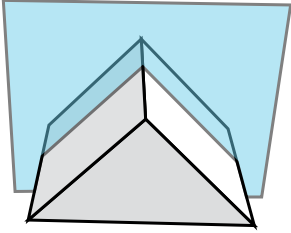

2)

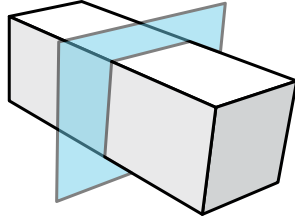

3)

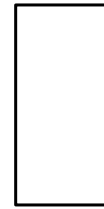
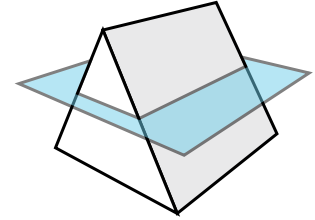

4)

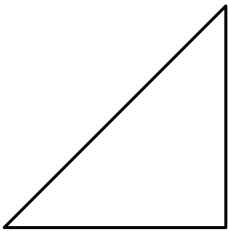
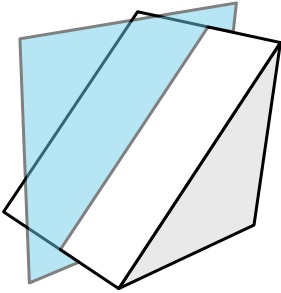

5)

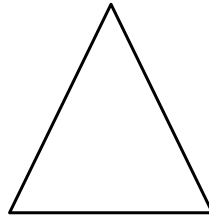
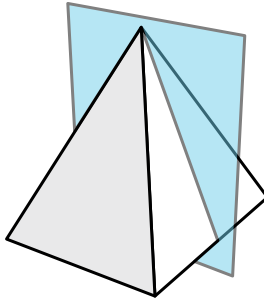

6)

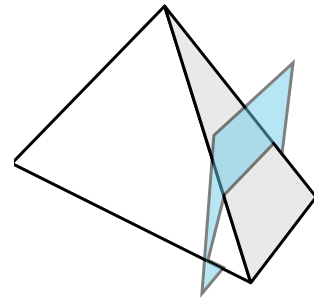

7)

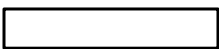
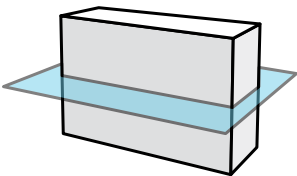

8)

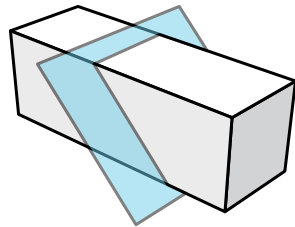

9)

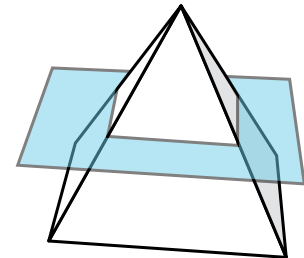



Determine the 2d shape that would be created if the 3d shape were sliced as shown.

1)

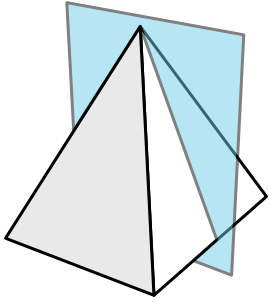

2)

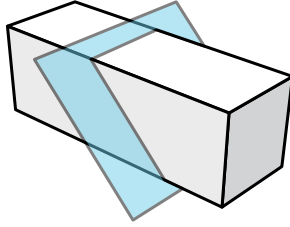

3)

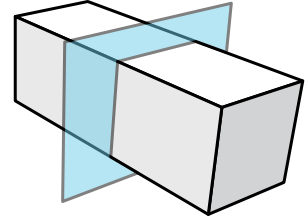

4)

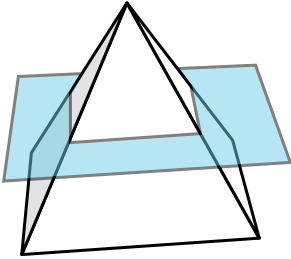

5)

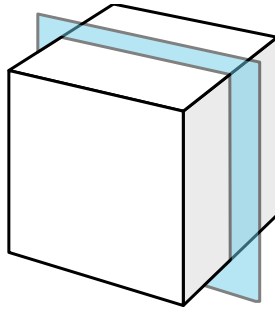

6)

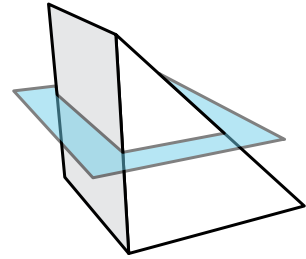

7)

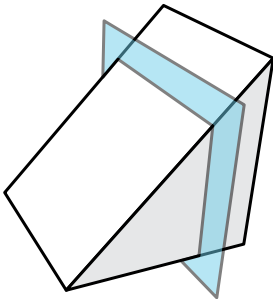

8)

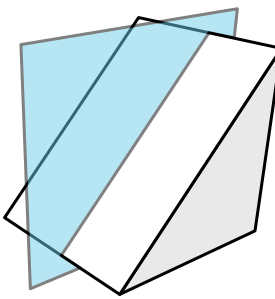

9)

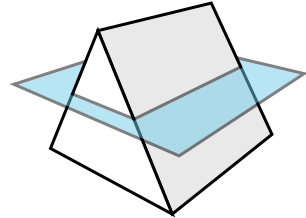



Determine the 2d shape that would be created if the 3d shape were sliced as shown.

1)

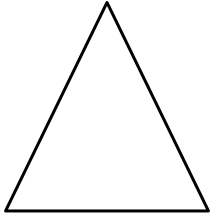
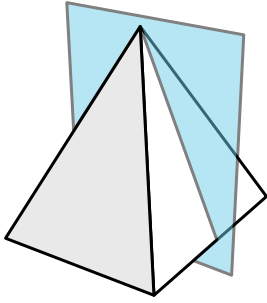

2)

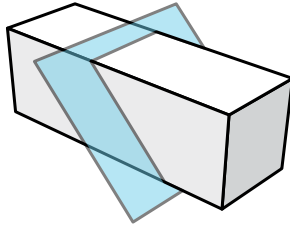

3)

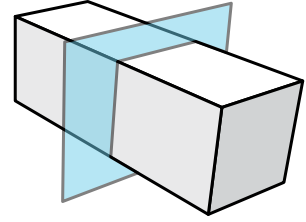

4)

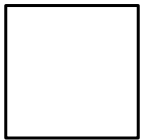
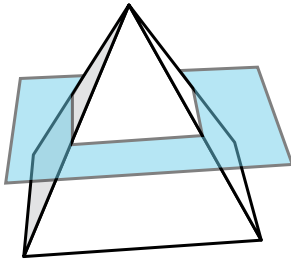

5)

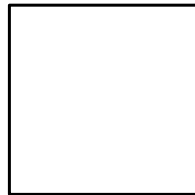
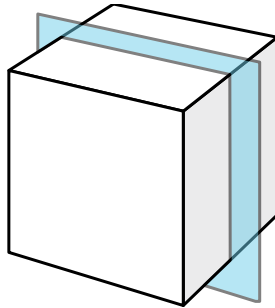

6)

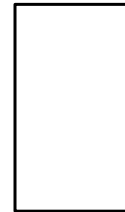
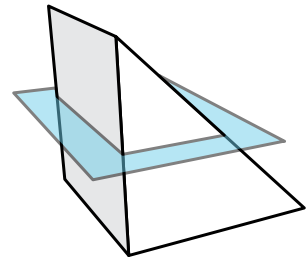

7)

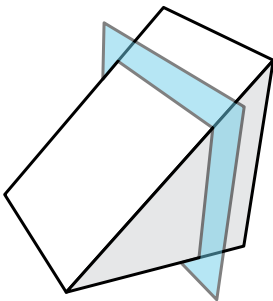

8)

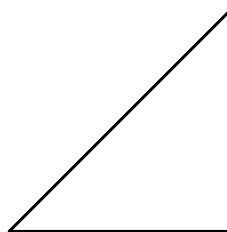
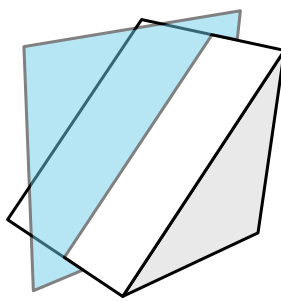

9)

