

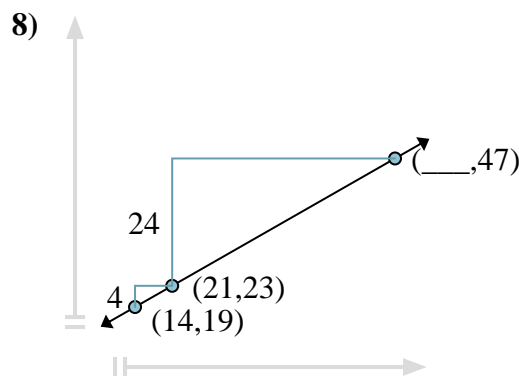

Find the missing coordinate in each problem.

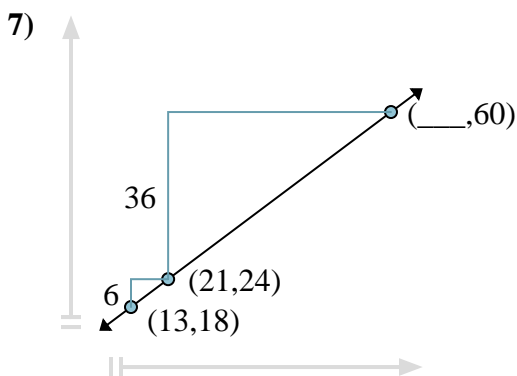
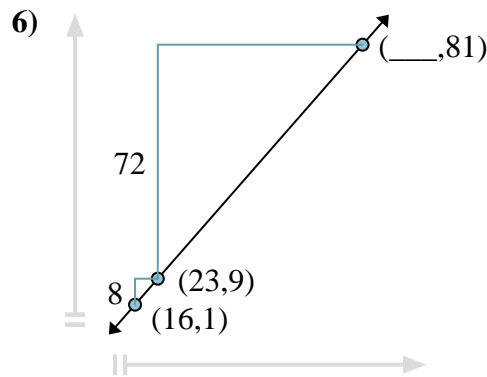
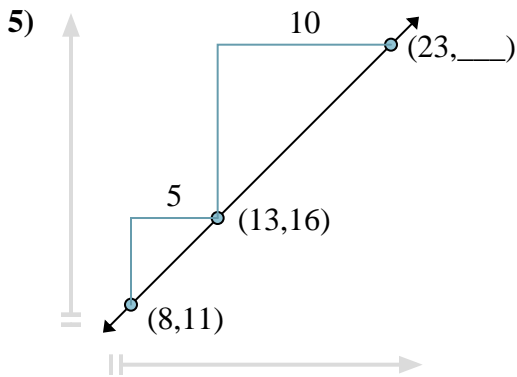
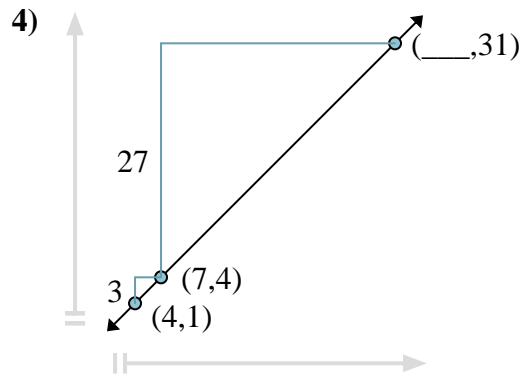
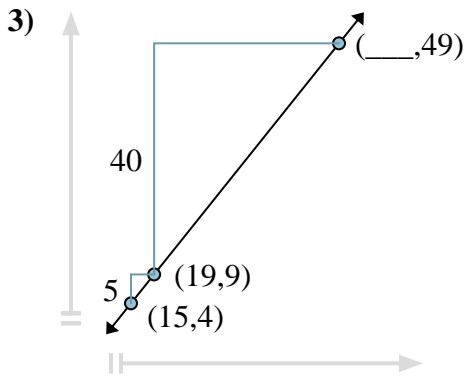
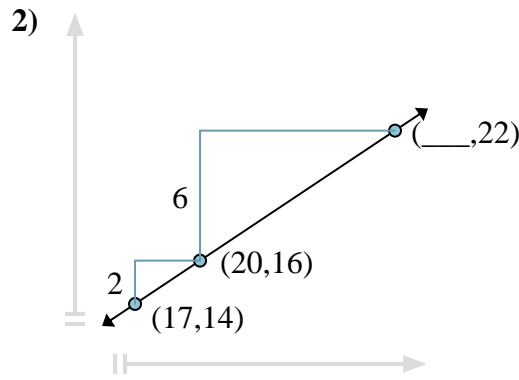
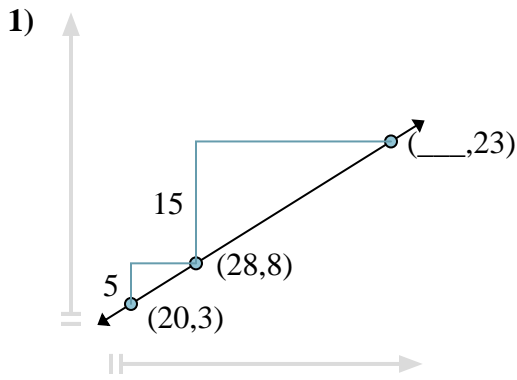

Answers

1. \_\_\_\_\_
2. \_\_\_\_\_
3. \_\_\_\_\_
4. \_\_\_\_\_
5. \_\_\_\_\_
6. \_\_\_\_\_
7. \_\_\_\_\_
8. \_\_\_\_\_



Find the missing coordinate in each problem.

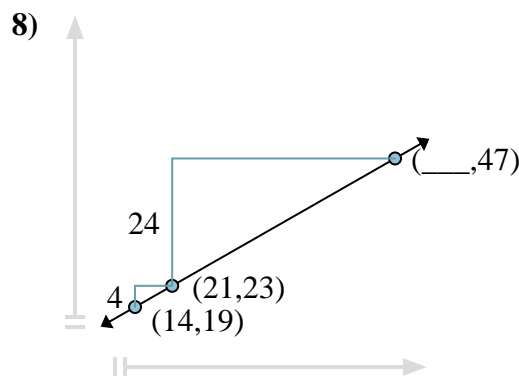
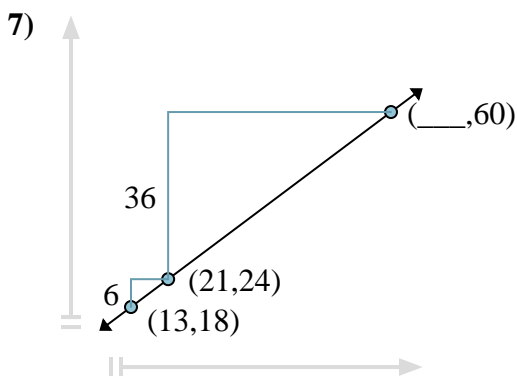
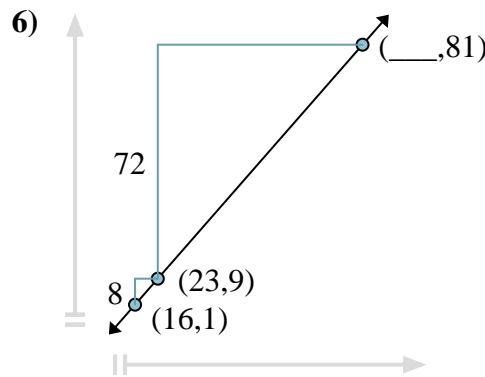
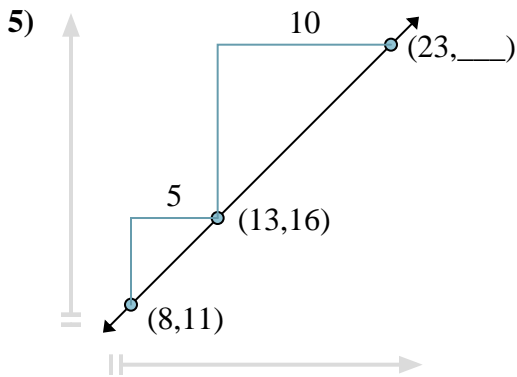
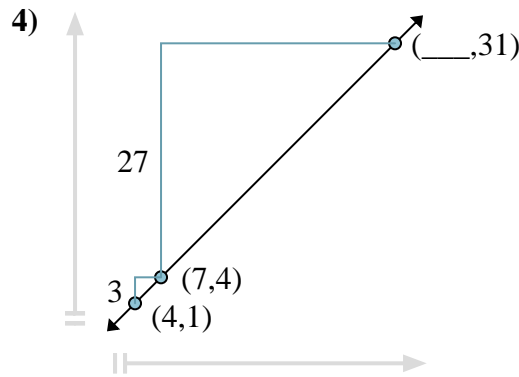
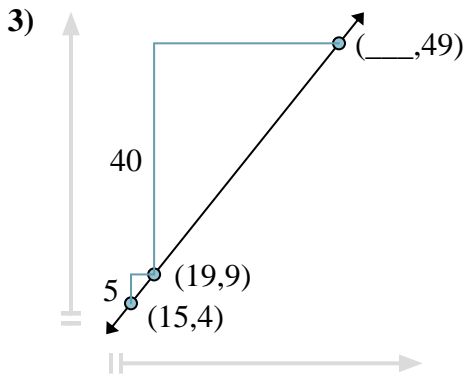
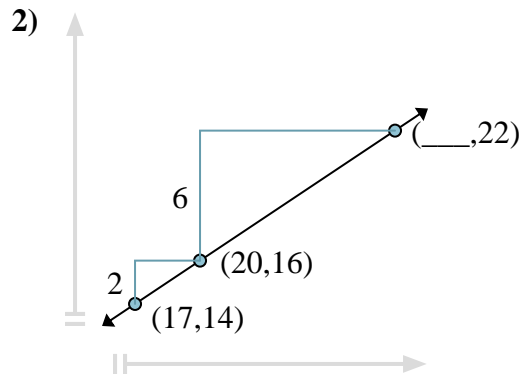
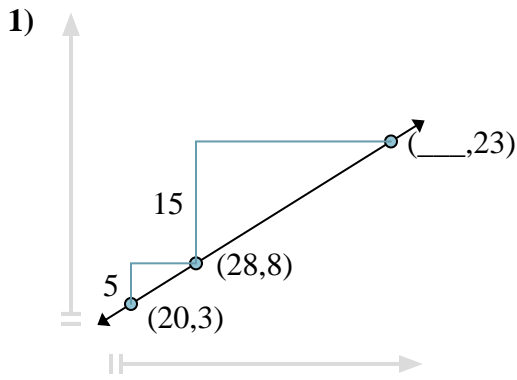

Answers

1. 52

2. 29

3. 51

4. 34

5. 26

6. 86

7. 69

8. 63