

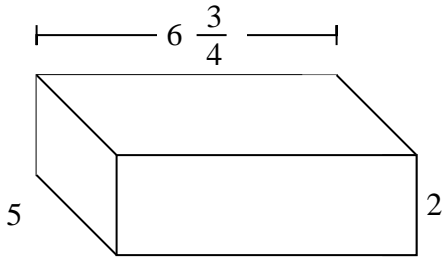

Fill each rectangular prism with cubes to determine the volume. Each prism's unit is measured in cm (not to scale).

Ex)



1)

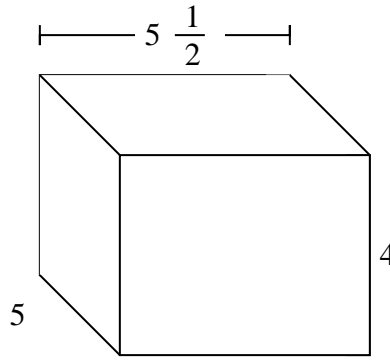

2)

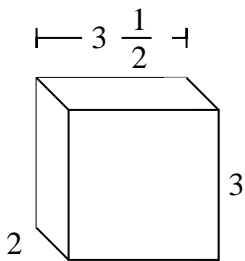

3)

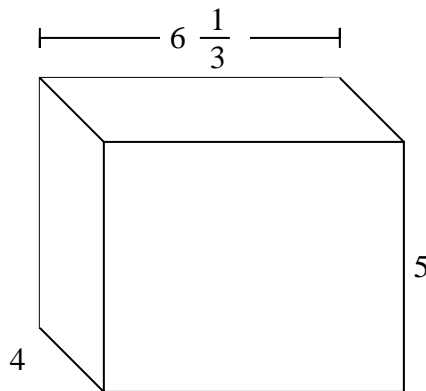

4)

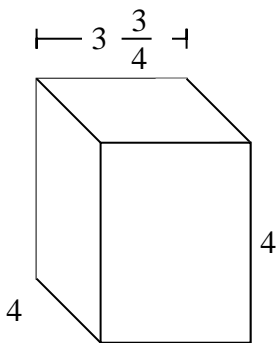

5)

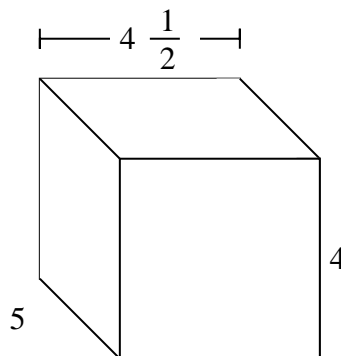

6)

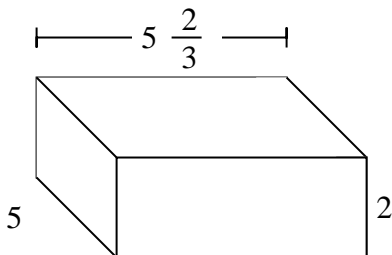

7)

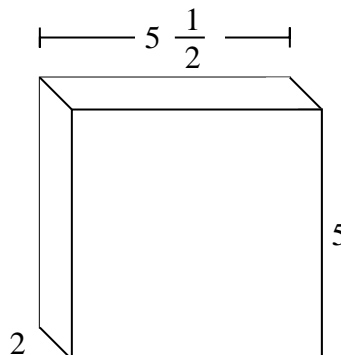
AnswersEx. $67 \frac{2}{4}$ cm

1. _____

2. _____

3. _____

4. _____

5. _____

6. _____

7. _____



Fill each rectangular prism with cubes to determine the volume. Each prism's unit is measured in cm (not to scale).

Ex)

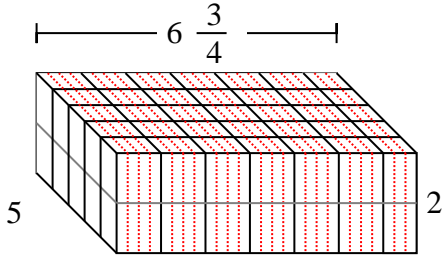

1)

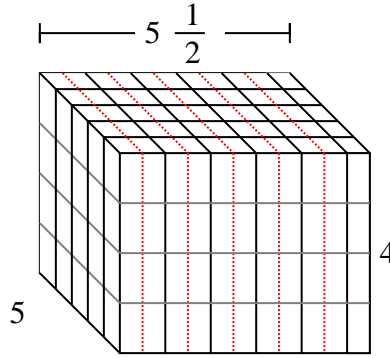
Ex. $67 \frac{2}{4}$ cm1. 110 cm2. 21 cm3. $126 \frac{2}{3}$ cm4. 60 cm5. 90 cm6. $56 \frac{2}{3}$ cm7. 55 cm

2)

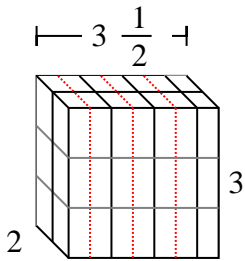

3)

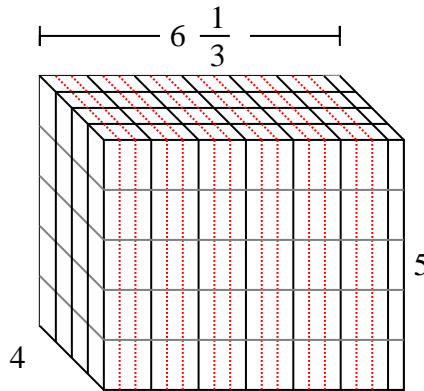

4)

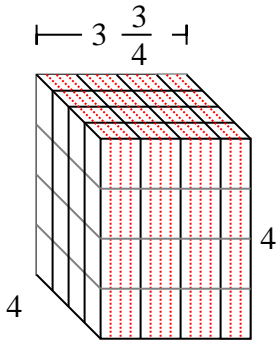

5)

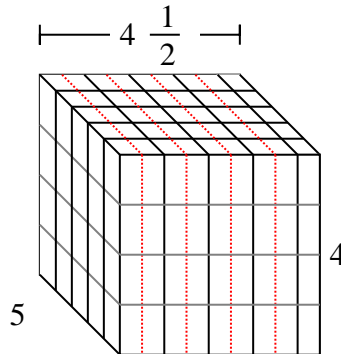

6)

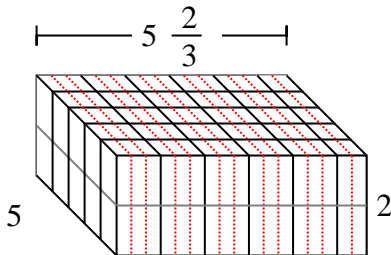

7)

