

Find the value of angle 'A' and angle 'B'.

1)

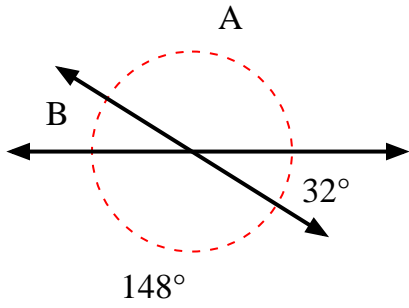

2)

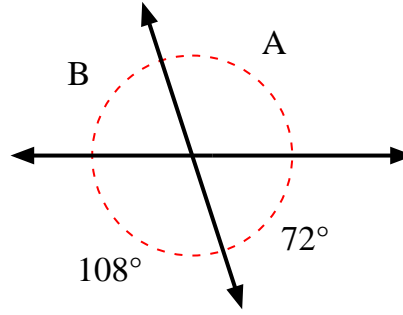

3)

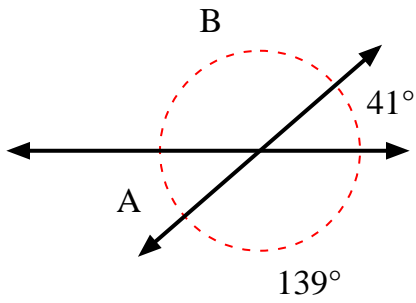

4)

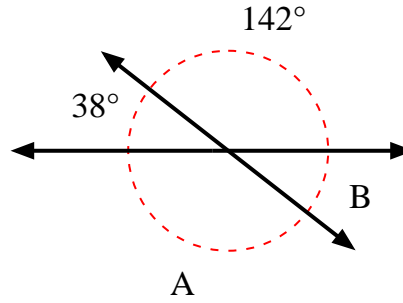

5)

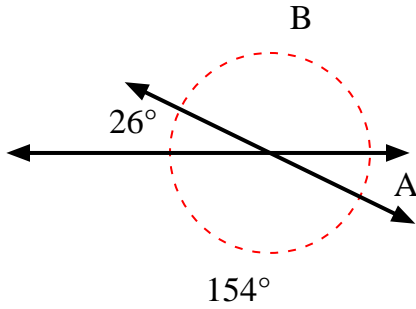

6)

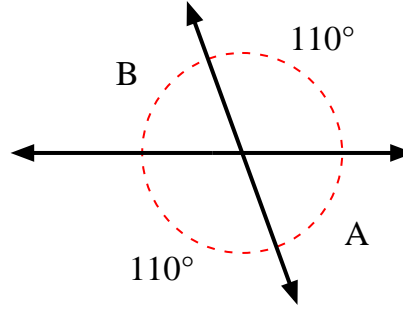

7)

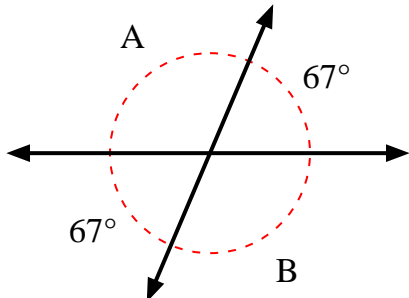

8)

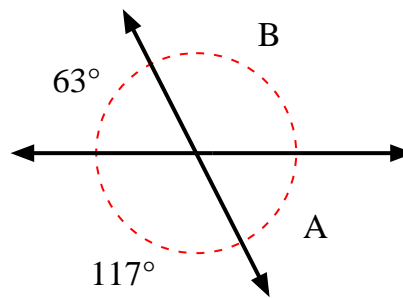

Answers

1. _____
2. _____
3. _____
4. _____
5. _____
6. _____
7. _____
8. _____

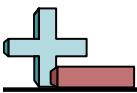

Find the value of angle 'A' and angle 'B'.

1)

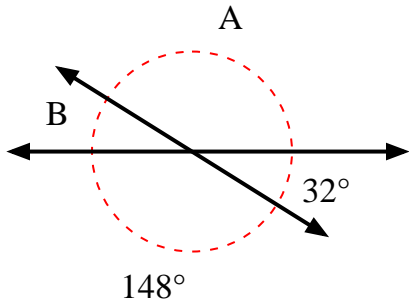

2)

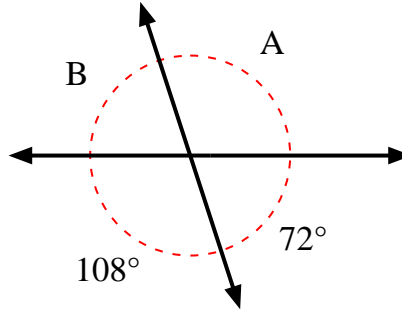

3)

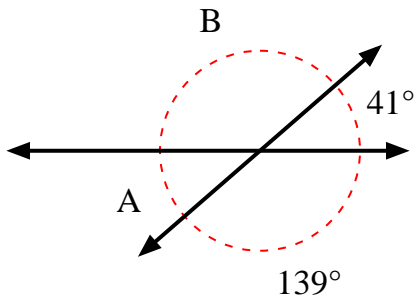

4)

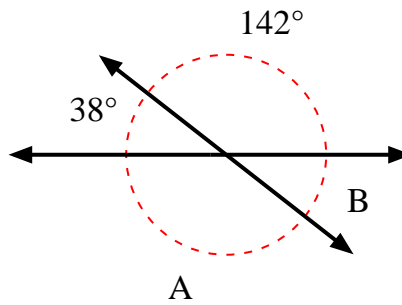

5)

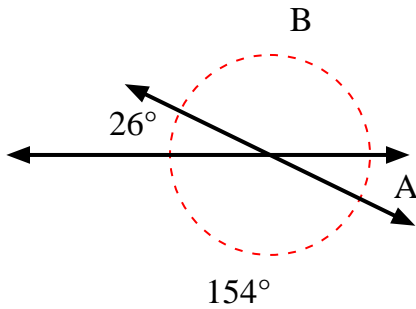

6)

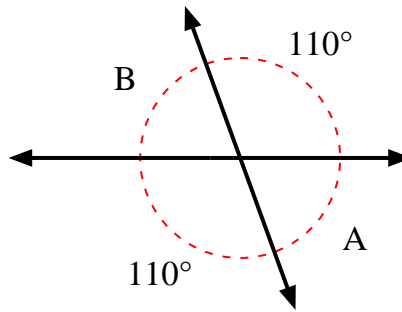

7)

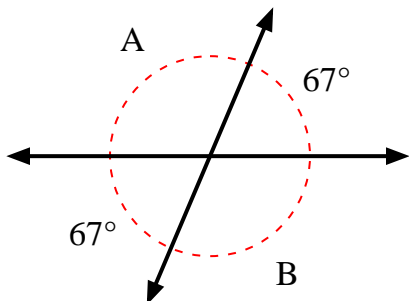

8)

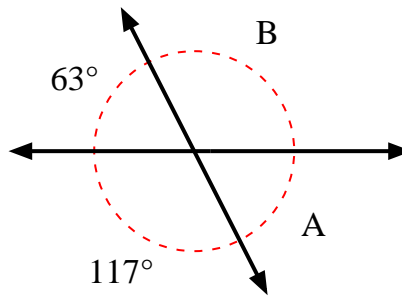

Answers

1.	148°	32°
2.	108°	72°
3.	41°	139°
4.	142°	38°
5.	26°	154°
6.	70°	70°
7.	113°	113°
8.	63°	117°