

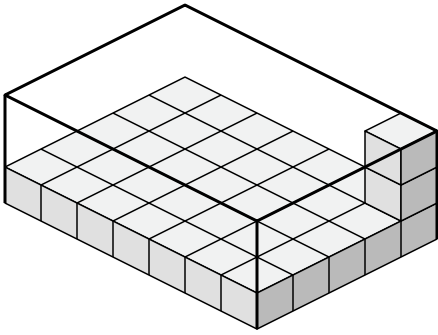

Determine the volume of each box. Each block is 1 cubic unit (u³).

1)



2)

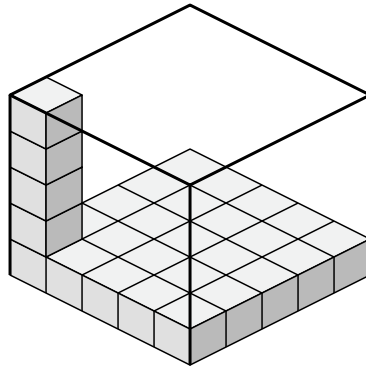

3)

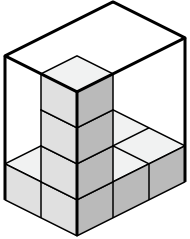

4)

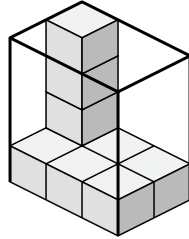

5)

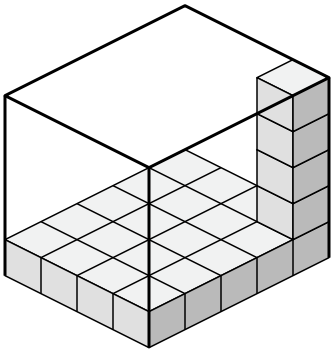

6)

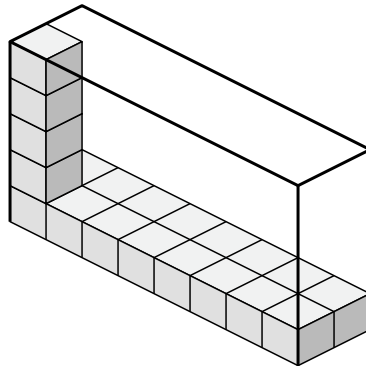

7)

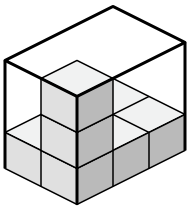

8)

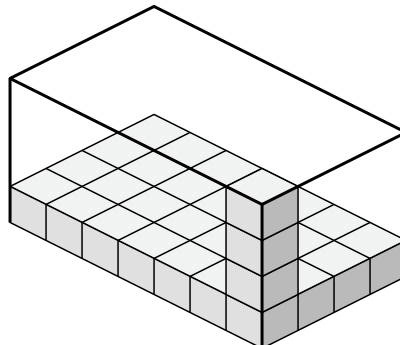

Answers

- 1. _____
- 2. _____
- 3. _____
- 4. _____
- 5. _____
- 6. _____
- 7. _____
- 8. _____



Determine the volume of each box. Each block is 1 cubic unit (u^3).

1)

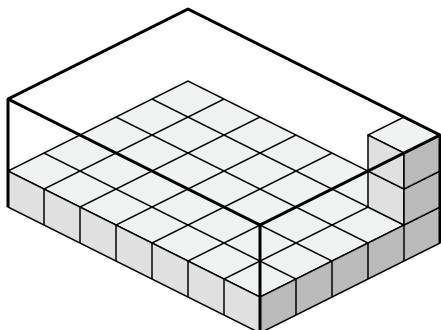

2)

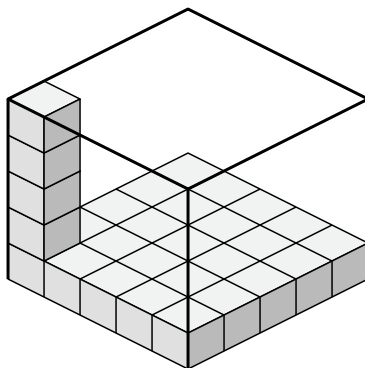

3)

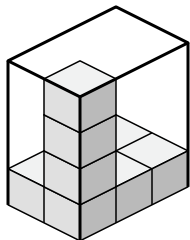

4)

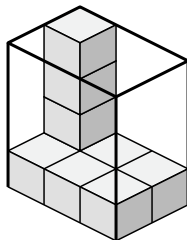

5)

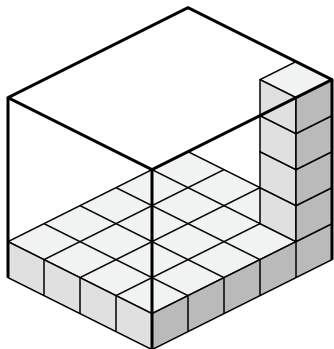

6)

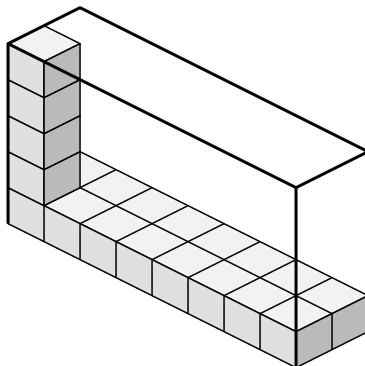

7)

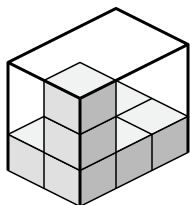

8)

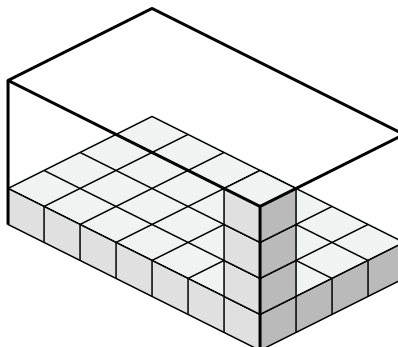

Answers

1. 105 u^3

2. 125 u^3

3. 24 u^3

4. 24 u^3

5. 100 u^3

6. 80 u^3

7. 18 u^3

8. 112 u^3