

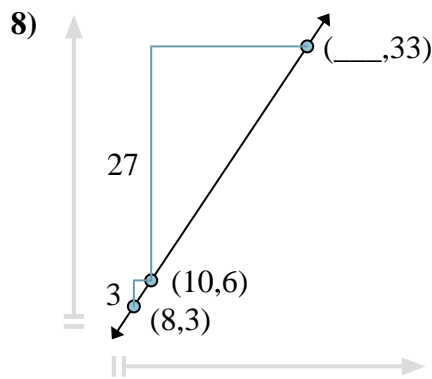

Find the missing coordinate in each problem.

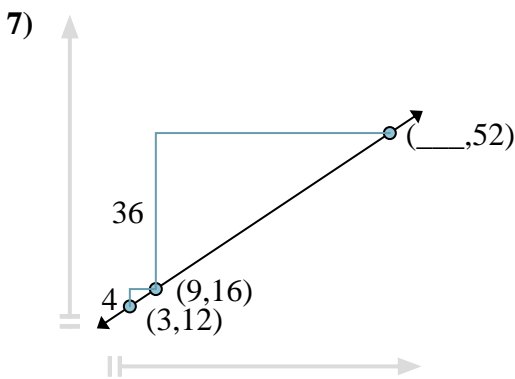
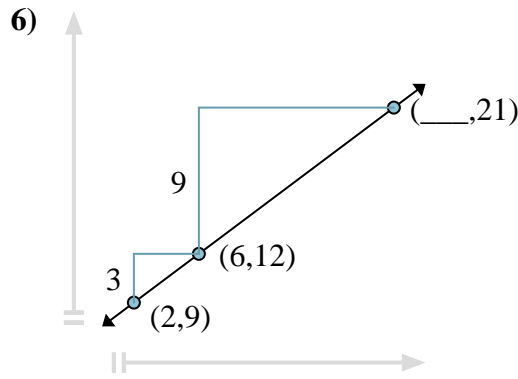
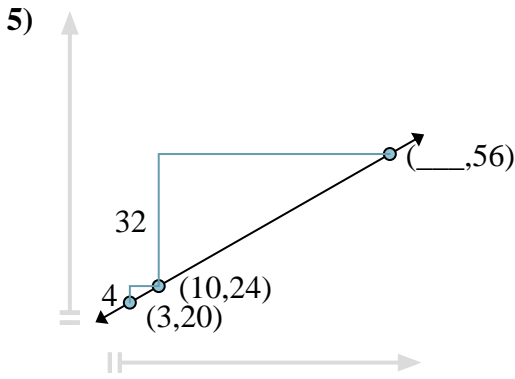
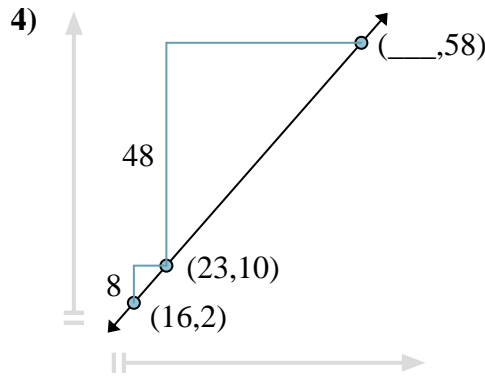
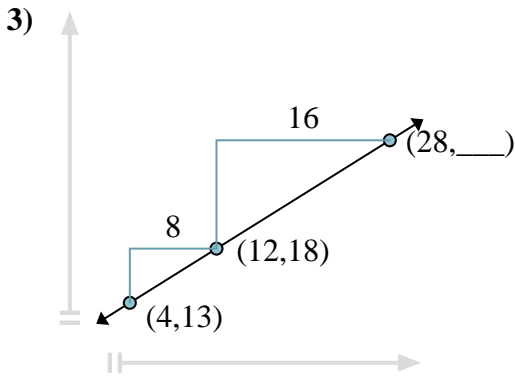
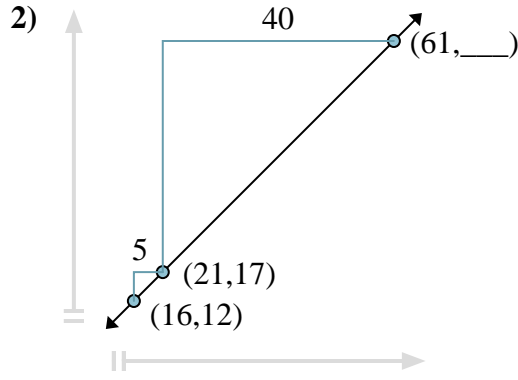
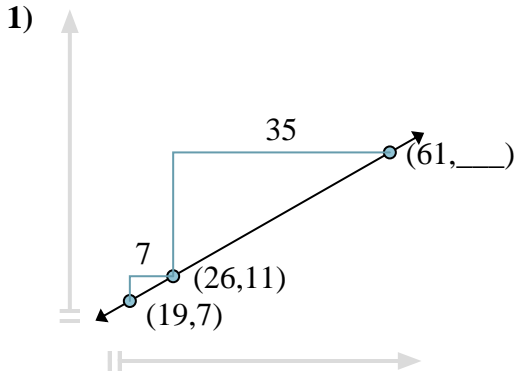

Answers

1. \_\_\_\_\_
2. \_\_\_\_\_
3. \_\_\_\_\_
4. \_\_\_\_\_
5. \_\_\_\_\_
6. \_\_\_\_\_
7. \_\_\_\_\_
8. \_\_\_\_\_



Find the missing coordinate in each problem.

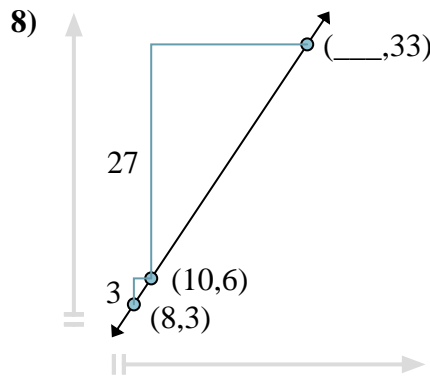
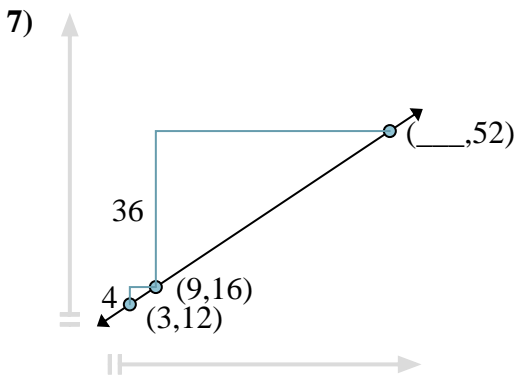
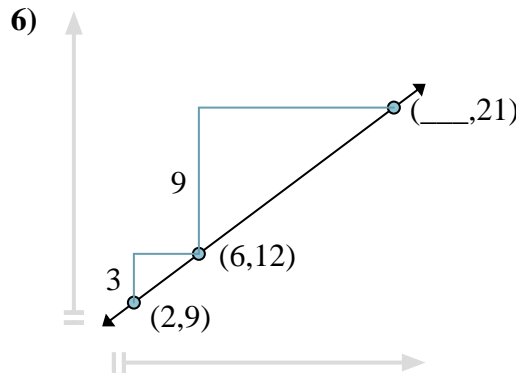
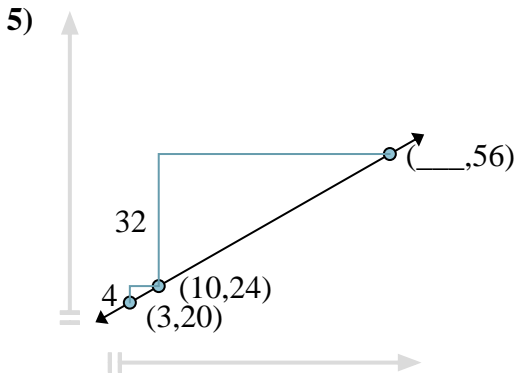
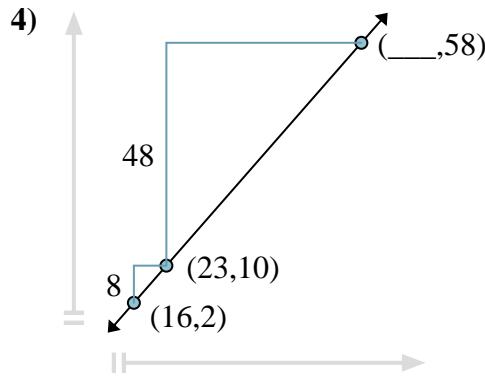
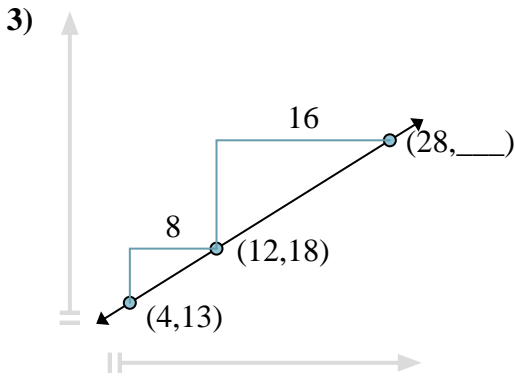
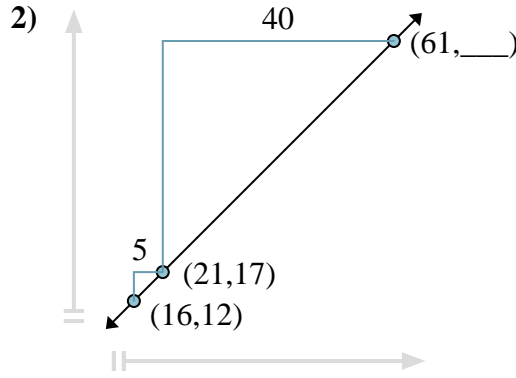
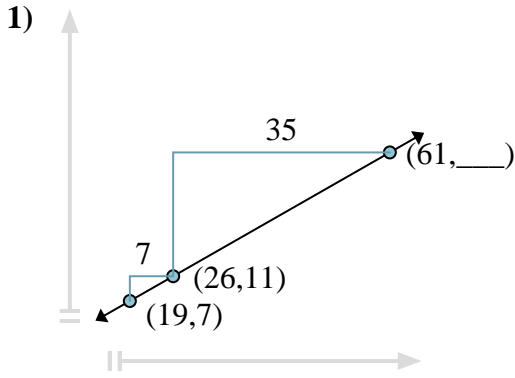

Answers

1. 31
2. 57
3. 28
4. 65
5. 66
6. 18
7. 63
8. 28